

Container 250ml/ 89mm with screw

Product code: 00028209







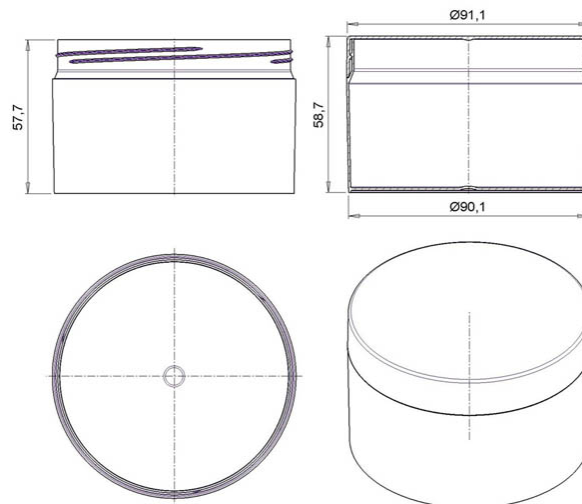

Volume, ml	250
Lid size, mm	89
Height, mm	59
Base shape	Round
Side wall shape	Straight
Types of closures	-
Types of lids	Leakproof
IML on body	-
IML on the lid	-





Minimum order quantity	Body	Lid	Set
Pieces per box	150	450	450
Logistics	Body	Lid	Set
Pieces per box	150	450	450
Box size (mm)	580x370x375	580x370x295	-
Box weight with product (kg)	3,1	4,9	14,3
Volume (m3)	0,095	0,075	0,36
Quantity of boxes (pcs)	3	1	4
Quantity in pallet (pcs)	3 000	12 600	-
Pallet weight with goods (kg)	84	159	-
Pallet height with goods (m)	2,03	2,22	-



-  Fish processing
-  Dairy products
-  Confectionery

-  HoReCa
-  Fats & Oils
-  Cooking

-  Laquers & Paints
-  Pet food
-  Cosmetics

-  Fasteners
-  Fishing gear
-  Household chemicals

